

SIDE VIEW

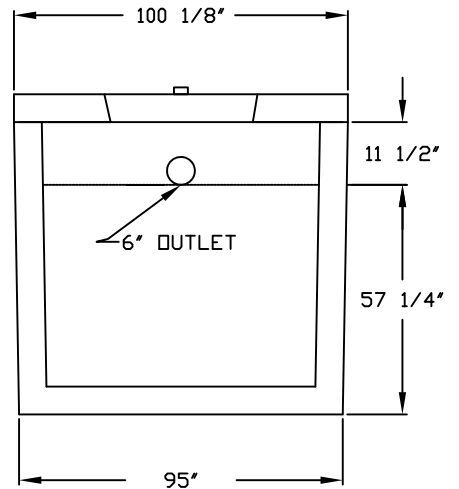

END VIEW

TANK: CATEGORY 3. 4" 3500 GALLON 2 COMPARTMENT TANK REINFORCED WITH #3 STEEL 12" O/C. BOTH WAYS. 4" WALLS AND 4" BOTTOM. INLET AND OUTLET RESILIENT CONNECTORS PER ASTM-923-98. CONNECTORS MUST BE USED WITH APPROVED CLAMP. CONNECTOR WILL ACCEPT 6" PVC PIPE.

LIDS: 5" LID WITH 1-22" ROUND MANHOLE COVER AT EACH END OF TANK  
 8" LID WITH 1-22" ROUND MANHOLE COVER AT EACH END OF TANK  
 BOTH LIDS ARE REINFORCED WITH GRADE 60 REBAR.

TANK & LIDS: 4000 PSI CONCRETE AT 28 DAYS

IMPRINTED ON INLET END OF TANK:

LEGEND: FSI3500 STATE APPROVAL: 01-011-66D-C3

WEIGHTS: TANK ONLY 18,130  
 TANK W/ 5" LID 25,520  
 TANK W/ 8" LID 29,950

THIS SEWAGE TREATMENT RECEPTACLE HAS BEEN DESIGNED, CONSTRUCTED AND STRUCTURALLY TESTED IN ACCORDANCE WITH CHAPTER 64E-6.013, FLORIDA ADMINISTRATIVE CODE, (FAC) DATED APRIL 28, 2010.

DRAWING NOT TO SCALE

**FLORIDA SEPTIC, INC.**  
 P.O. BOX 545  
 HAWTHORNE, FLORIDA 32640  
 (800) 940-8265

MODEL:  
 4" 3500 GAL. TANK

REVISED:  
 05/01/2011

APPROVAL DATE:  
 02/14/2008