

SIDE VIEW

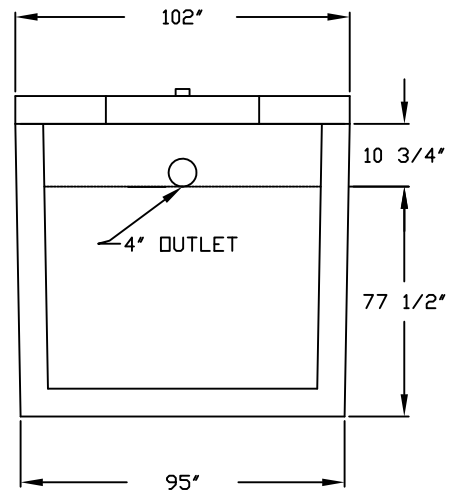

END VIEW

TANK: CATEGORY 3. 4" 5000 GALLON 2 COMPARTMENT TANK REINFORCED WITH #4 STEEL 12" O/C. BOTH WAYS. 4" WALLS AND 4" BOTTOM. INLET AND OUTLET RESILIENT CONNECTORS PER ASTM-923-98. CONNECTORS MUST BE USED WITH APPROVED CLAMP. CONNECTOR WILL ACCEPT 4" PVC PIPE.

**LIDS: 5" LID WITH 1-22" ROUND MANHOLE COVER AT EACH END OF TANK
8" LID WITH 1-22" ROUND MANHOLE COVER AT EACH END OF TANK
BOTH LIDS ARE REINFORCED WITH GRADE 60 REBAR.**

TANK & LIDS: 4000 PSI CONCRETE AT 28 DAYS

IMPRINTED ON INLET END OF TANK:

LEGEND: FSI5000

STATE APPROVAL: 01-011-76D-C3

**WEIGHTS: TANK ONLY 22,110
TANK W/ 5" LID 29,500
TANK W/ 8" LID 33,930**

THIS SEWAGE TREATMENT RECEPTACLE HAS BEEN DESIGNED, CONSTRUCTED AND STRUCTURALLY TESTED IN ACCORDANCE WITH CHAPTER 64E-6.013, FLORIDA ADMINISTRATIVE CODE, (FAC) DATED APRIL 28, 2010.

DRAWING NOT TO SCALE

FLORIDA SEPTIC, INC.
P.O. BOX 545
HAWTHORNE, FLORIDA 32640
(800) 940-8265

MODEL:
4" 5000 GAL. TANK

REVISED:
05/01/2011

APPROVAL DATE:
08/14/2001